

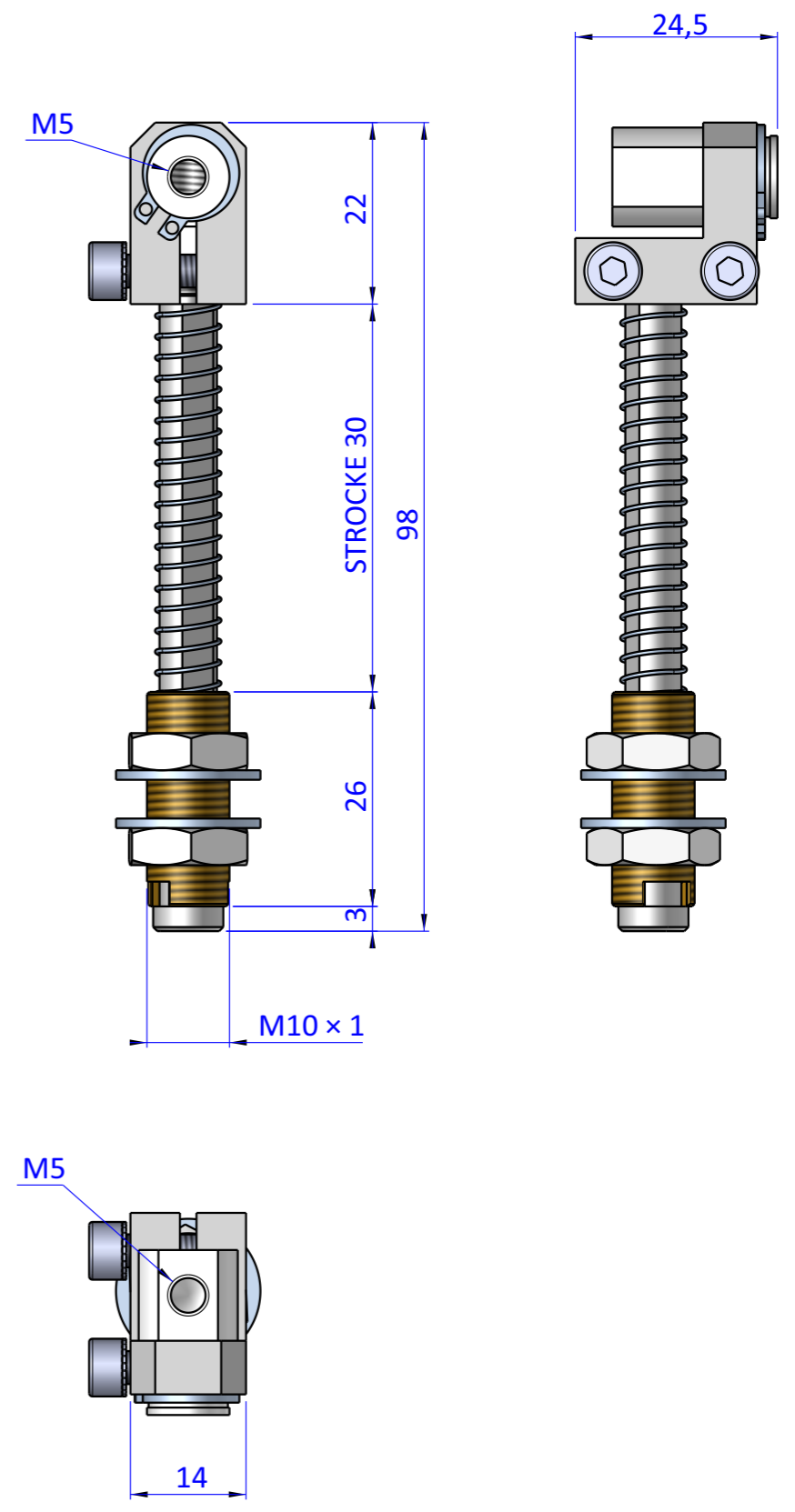

THE PROPERTY OF THE DRAWING IS ESTABLISHED BY LAW. IT IS FORBIDDEN TO PRODUCE OR SHOW IT TO THIRD PART. WITHOUT A WRITTEN AGREEMENT.

Item	Name	Q.ty
1	05.01.005.02	1
2	05.01.005.06	2
3	05.01.005.09	1
4	A.ELA10	1
5	GG.S.01.01	1
6	GG.S.02.01	1
7	M.8x60	1
8	R.4.SCH	2
9	R.10.SCH	2
10	V.TCE4x14	2

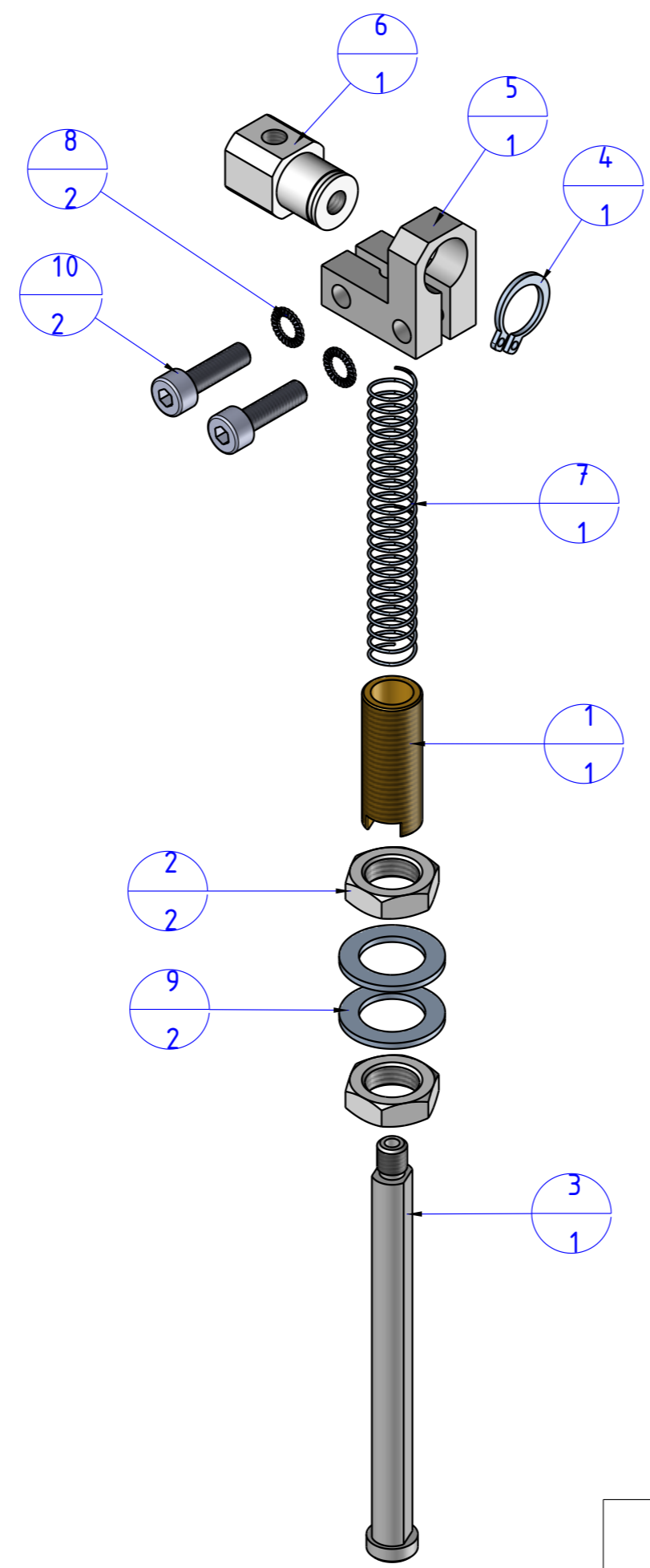

Format A3
UNI 936-76

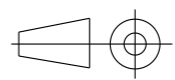
 FPS FPSERVICES AUTOMATION			DESIGNED FROM FPS Automation	REVIEW A
GENERAL TOLERANCE UNI - ISO 2768 CLASSE f	DESCRIPTION CA.GGSM100530	DATE -	WEIGHT 0,049kg	CODE CA.GGSM100530